

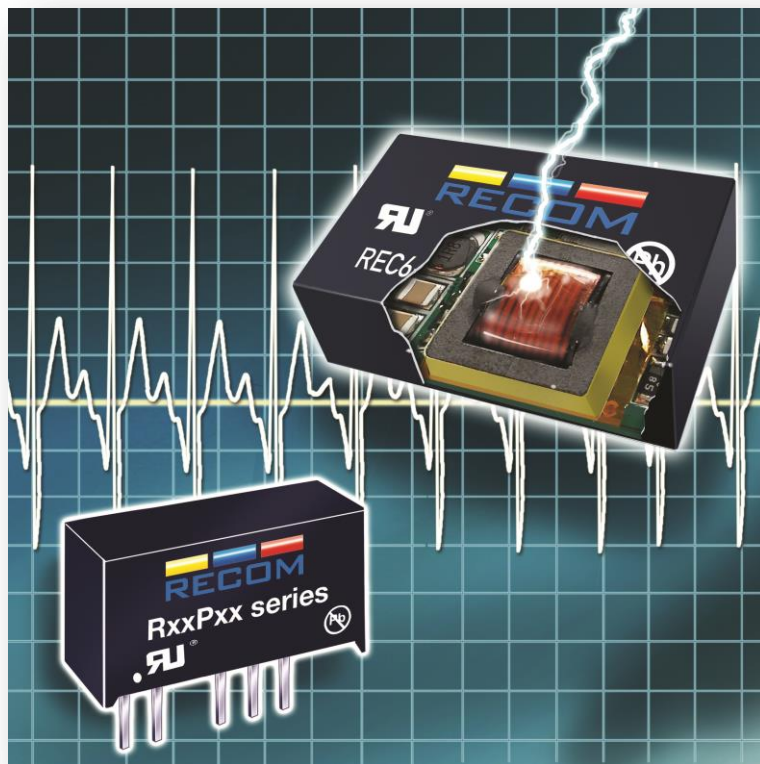

Whitepaper

## Isolated DC/DC Converters



January 2017

## Table of contents

1	ABOUT DC/DC-CONVERTERS .....	1
2	ISOLATED DC/DC-CONVERTERS .....	1
3	CLASSES OF ISOLATION .....	2
3.1	Operational/Functional Isolation .....	2
3.2	Basic Isolation .....	3
3.3	Reinforced Isolation .....	4
4	CLEARANCES & CREEPAGES.....	4
5	APPLICATIONS.....	6
5.1	High Voltage Circuits.....	6
5.2	Power Metering Systems .....	7
5.3	Medical Field .....	8
5.4	IGBT Controllers (Insulated-Gate Bipolar Transistor) .....	8
6	CONCLUSION.....	10

## List of figures

Figure 1: Basic layout of a DC/DC-converter.....	1
Figures 2 & 3: Some Isolated and non-isolated supply configurations.....	1
Figure 4: Ring core transformer.....	2
Figure 5: Bobbin transformer.....	2
Figure 6: Bobbin transformer with basic isolation .....	3
Figure 7: Bridged transformer .....	3
Figure 8: Potted core transformer construction.....	3
Figure 10: Example - PCB bottom-side layout showing track separation of 3.65mm.....	5
Figure 11: Example – MAGIC-Telescope with integrated Photomultiplier .....	6
Figure 12: Example - Laser Power Supply, X-Ray Generator, Mass Spectroscope.....	6
Figure 13: Power Metering.....	8
Figure 14: Example – Medical Equipments.....	8
Figure 15: Example of a mains-powered medical equipment with two isolation barriers.....	8
Figure 16: Example – Motor & Pump Controllers, Wind & Sea Turbines, Photovoltaic Panels .....	9
Figure 17: Block diagram of a 3 Phase, 3-Level IGBT Inverter.....	9

## List of tables

Table 1: UL-defined values for clearance and creepage relative to the input voltage.....	4
Table 2: Isolation equivalence table to show the derating required coping with longer times or AC voltages .	7

## 1 ABOUT DC/DC-CONVERTERS

DC/DC-converters are power supplies that can change one DC supply voltage into another DC voltage - in other words they can act like an isolating transformer or a step-up or step-down transformer but with constant voltage DC supplies instead of AC mains supplies.

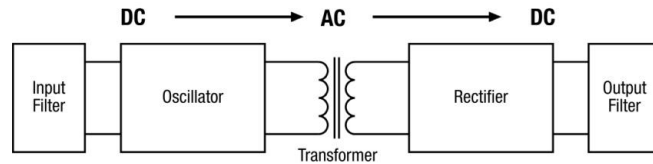
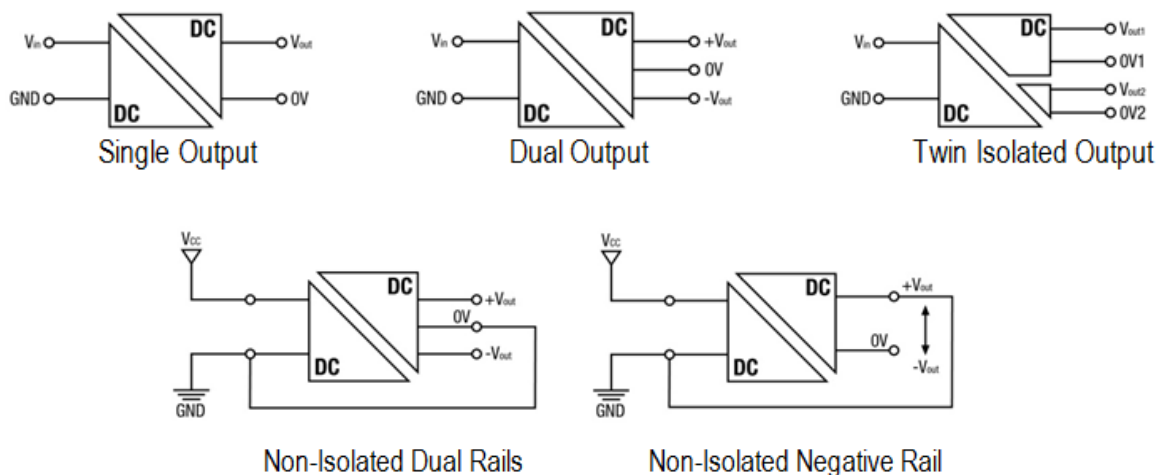

Figure 1: Basic layout of a DC/DC-converter

## 2 ISOLATED DC/DC-CONVERTERS

Although DC/DC-converters exist without input-output isolation, most DC/DC-converters use an internal transformer and the output is electrically (galvanically) isolated from the input. The basic input to output isolation can be used to provide either a simple isolated output power source or to generate different voltage rails and/or dual polarity rails (Figure 2). Since the output is isolated from the input, the choice of reference voltage for the input or output side can be arbitrary (Figure 3), for example, a DC/DC can be used to change the voltage polarity (e.g. -5V out from +5V in), add a voltage (e.g. +12V from a +5V supply) or generate a dual output from a single supply (e.g.  $\pm 5V$  from a 12V battery). This makes DC/DC converter very versatile. Having outputs that are floating with respect to the input is also very useful – the isolation breaks ground loops and thus eliminates noise in electrical systems, the output polarity can be freely chosen and, of course, the isolation barrier is an important safety element to prevent electric shock and to reduce fire hazards.



Figures 2 & 2: Some isolated and non-isolated supply configurations.

### 3 CLASSES OF ISOLATION

There are three main classes of isolation:

- 3.1 Operational or Functional (the output is isolated, but there is no fault protection)
- 3.2 Basic (the transformer offers single fault protection)
- 3.3 Reinforced (2 layers of insulation that offer double fault protection)

So how do these definitions translate into practical transformer construction?

#### 3.1 Operational/Functional Isolation

The input and output windings are wound directly over one another on a ring core, relying on the thickness of the lacquer for isolation (figure 4). This method has the advantage of a very compact sized transformer which, despite the small size, can withstand 4kVDC isolation testing.

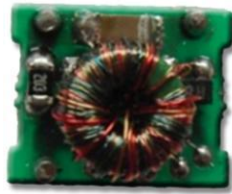

**Figure 3:** Ring core transformer

Another type of transformer construction is to wind the input and output windings over one another on a bobbin core (figure 5). This method still relies on the thickness of the lacquer for isolation, but permits double- or triple-coated wires to be used. This method has the advantage of a very compact sized transformer that can deliver more power and offers isolations of up to 6kVDC.



**Figure 4:** Bobbin transformer

### 3.2 Basic Isolation

The input and output windings are not wound directly over one another, but are separated with a physical barrier, such as an insulating film (figure 6). This method can be used in larger sized transformers where there is enough room to add layers of tape between the windings (see Table 1).

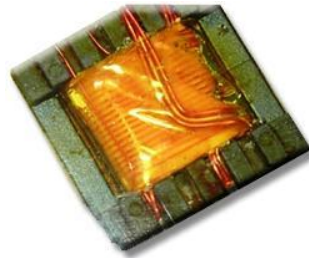

**Figure 5:** Bobbin transformer with basic isolation

For compact DC/DC converters, other ways must be found to provide basic isolation without making the transformer too big. Figure 7 shows a transformer which uses a separation bridge to physically separate the windings. In addition, the ferrite ring core is plastic coated, so it is also independently isolated from the windings.



**Figure 6:** Bridged transformer

There is also another way of making a basic insulated transformer, namely the potted core. In this method of construction, the core and one winding are placed in a plastic pot which is filled with epoxy. A lid is fitted and then the second winding is wound around the whole construction through the hole in the middle.



**Step 1:** Primary winding



**Step 2:** Potting



**Step 3:** Lid fitted & secondary wound around case

**Figure 7:** Potted core transformer construction

### 3.3 Reinforced Isolation

With reinforced isolation, the input and output windings are separated by at least two physical barriers (Figure 9) and the transformer has increased creepage and clearance dimensions (see Table 1).

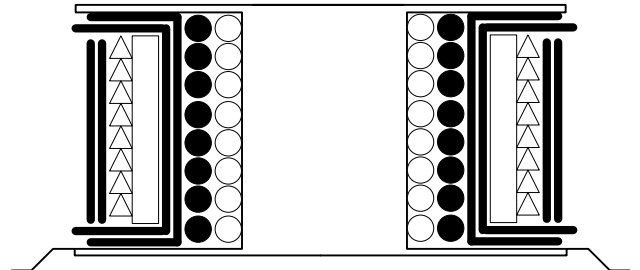
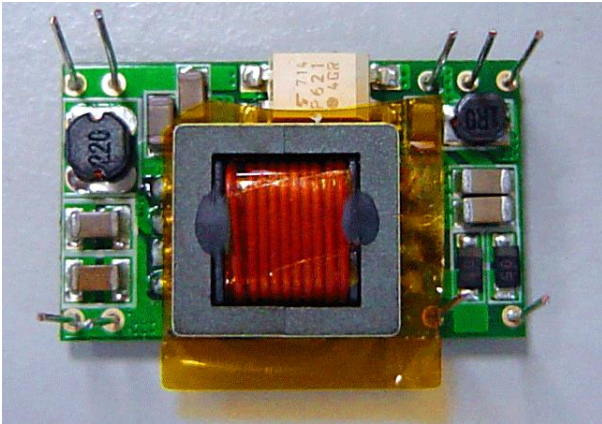

**Figure 9:** Example of a reinforced transformer construction with increased creepage separation and two layers of insulation.

## 4 CLEARANCES & CREEPAGES

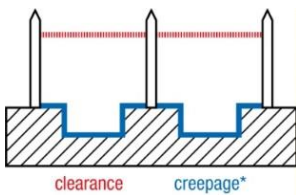

Clearance is the shortest distance between two points measured point to point (arcing distance).

Creepage is the shortest distance between two points measured by following the surface (tracking distance).

Isolation Class	Input Voltage	15 VDC 12 VAC	36 VDC 30 VAC	75 VDC 60 VAC	150 VDC 125 VAC	300 VDC 250 VAC
Operational/ Functional*	Clearance	0.4 mm	0.5 mm	0.7 mm	1.0 mm	1.6 mm
	Creepage	0.8 mm	1.0 mm	1.3 mm	2.0 mm	3.0 mm
Basic	Clearance	0.8 mm	1.0 mm	1.2 mm	1.6 mm	2.5 mm
	Creepage	1.7 mm	2.0 mm	2.3 mm	3.0 mm	4.0 mm
Reinforced	Clearance	1.6 mm	2.0 mm	2.4 mm	3.2 mm	5.0 mm
	Creepage	3.4 mm	4.0 mm	4.6 mm	6.0 mm	8.0 mm

**Table 1:** UL-defined values for clearance and creepage relative to the input voltage  
\* For functional isolation, the clearance and creepage is measured outside of the transformer.

Please note: Creepage and clearance are based on the sum of the input and output voltages (e.g. 24V±10% in, 5V out = 31.4VDC working voltage) and not the primary power supply voltage, unless the converter is specified for 250VAC working voltage.

The clearances and creepages within the transformer depend on the construction:

Functional designs have creepages and clearances equal only the thickness of the transformer wire lacquer, e.g. 0.016mm.

The bridged transformer construction has a creepage and clearance equal to the thickness of the separation bridge (2mm), while the pot core construction has a clearance equal to double the wall thickness of the plastic pot (0.5mm + 0.5mm) but a creepage of a minimum of 3mm.

Reinforced transformers using triple insulated wires (TIW) can meet the requirements for reinforced insulation within the transformer, but still need to meet clearance requirements between the transformer and adjacent components. The standard creepage and clearance separations apply to all of the other components, for example, the opto-coupler and any EMC capacitors bridging the isolation gap.

The values given in many standards which define creepage and clearance are given in air. The epoxy or injection moulding compound used in the converters has a dielectric strength of at least 15kV/mm, so very often, the converter can be treated as a homogenous unit and the creepage and clearances can be measured externally between the converter pins.

Nevertheless, the creepage between input and output tracks on the converter PCB is often requested. The separation is dependent on the converters, whether they are single or dual output and also on the various pinning options.

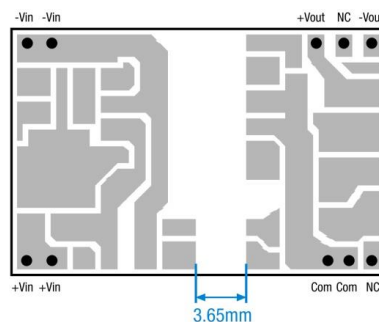

**Figure 8:** Example - PCB bottom-side layout showing track separation of 3.65mm  
Creepage is the minimum separation measured on both sides of the double-sided PCB.



## 5 APPLICATIONS

What kinds of applications need such a high isolation?

There are four main applications:

- 5.1 High Voltage Circuits
- 5.2 Power Metering Systems
- 5.3 Medical Field
- 5.4 IGBT Controllers

### 5.1 High Voltage Circuits

There are many industrial and laboratory applications that use high voltage supplies. One example is photo-multipliers used to detect light photons, either arising directly from low light sources or generated from particle physics interactions such as neutrino collisions, require precise high voltage DC power supplies. A DC/DC- converter can be used to power a monitoring circuit that is connected directly to the high voltage supply and thus is an essential component in the feedback circuit that stabilises the high DC Voltage.



**Figure 9:** Example – MAGIC-Telescope with integrated Photomultiplier

Another typical HV applications are laser power supplies, X-ray generators or Mass Spectroscopes – all of which commonly use power supplies with several thousand volts output.



**Figure 10:** Example - Laser Power Supply, X-Ray Generator, Mass Spectroscop



The isolation rating in a DC/DC-converter is specified as a DC voltage for a specific time, for example, 10kVDC for one second. This is the so-called “Hi-Pot” or flash test voltage which every converter has to meet. If the DC voltage is applied for a longer time, or is applied permanently, then the rated voltage has to be reduced as the increased stress on the transformer could eventually lead to isolation failure. Thus a converter rated at 10kV/1 second will withstand only 8kVDC/1 minute or 5kVDC permanently. Similarly, an AC voltage placed across the isolation barrier also additionally stresses the transformer and the isolation rating needs to be even further derated. Repeated testing also degrades the insulation. As a rule-of-thumb, every repeat test should reduce the test voltage by 20%.

It is important to ensure that no voltage gradients can occur within the device under test that would stress adjacent components. Therefore all input connections should be shorted together and all output connections shorted together before apply the insulation test voltage.

VDC			VAC		
1 Sec.	1 Min.	Cont.	1 Sec.	1 Min.	Cont.
500	400	-	350	250	-
1000	800	130	700	500	130
1500	1200	230	1080	750	230
2000	1600	550	1400	1000	550
3000	2400	1100	2100	1500	1100
4000	3200	1800	2800	2000	1800
6000	4800	3000	4200	3000	3000
8000	6400	4000	5600	4000	4000
10000	8000	5000	7000	5000	5000

**Table 2:** Isolation equivalence table to show the derating required coping with longer times or AC voltages [for information only]

## 5.2 Power Metering Systems

For a converter that has a flash test rating of 8kVDC, it is generally accepted that it will withstand continuous 4kVAC, which is an important specification for power metering. One of the major costs for electricity companies is reading the meter. Being able to remotely read the meter by simply driving past a customer’s house is a major time and cost saving. The radio transmitter needs however to measure the power consumption directly on the live supply, so needs a DC/DC to isolate the sensor. The requirement to withstand a continuous 4kVAC across the isolation gap may seem excessive, but power supply line transients, surges and lightning strikes need also to be taken into account. In addition, the power supply companies also want a secondary level of isolation besides that of the lacquer on transformer windings themselves. One of the main technical difficulties is to design a DC/DC-converter with both high voltage and reinforced isolation in a compact enough size to fit easily in most electrical meters.



**Figure 11:** Power Metering

### 5.3 Medical Field

A part of medical equipment that is directly connected to a patient needs two levels of electrical safety: The mains power supply to isolate the equipment from the 230VAC supply and a DC/DC-converter to isolate the patient from the equipment should something go wrong with the AC power supply. From the table 2, a DC/DC rated at 1500VDC/1sec should be able to block a continuous 230VAC across the isolation gap, but in practice, medical grade DC/DC-converters need at least 3kVDC isolation to give a factor of two of safety. However, some medical equipment may generate internal voltages of higher than 230VAC; in this case higher isolation DC/DC-converters are called for.



**Figure 12:** Example – Medical Equipments

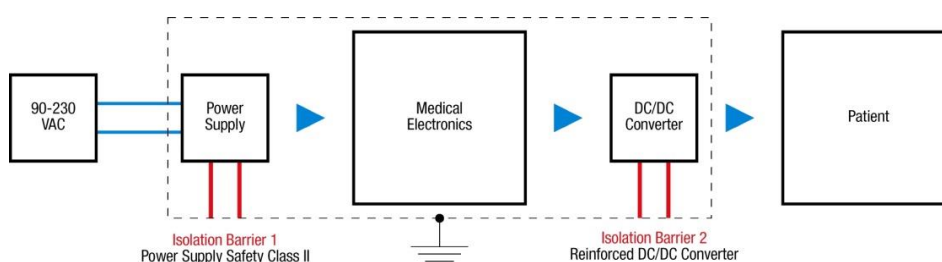

**Figure 13:** Example of a mains-powered medical equipment with two isolation barriers.

The first is within the primary AC/DC power supply (protection for the operator and patient from the hazardous supply voltage). The second is provided by the isolation of the secondary DC/DC-converter (protection for the patient from an earth leakage current)

### 5.4 IGBT Controllers (Insulated-Gate Bipolar Transistor)

These are used to efficiently convert high voltage DC supplies to single or three phase AC outputs and find applications in many fields from motor and pump controllers, wind and sea turbines, photovoltaic panels to almost all high power converters. The IGBT high side drivers run at the high voltage DC input which is

typically a few hundred volts. The power supply for the drivers is commonly generated by a DC/DC-converter. Again, from Table 2, a 2kVDC rated DC/DC-converter would seem adequate as it can withstand up to 550VAC continuous. However, IGBT drivers do not work at the mains frequency of 50Hz. At this low frequency they would be too inefficient. Instead, frequencies from 10's of kHz up to MHz are becoming more common. This high AC frequency and in particular the very fast slew rate (rate of change of voltage over time,  $dv/dt$ ) puts an enormous strain on the DC/DC transformer isolation, which can lead in time to isolation failure. **Therefore, for IGBT circuits, the higher the isolation, the better!**



**Figure 14:** Example – Motor & Pump Controllers, Wind & Sea Turbines, Photovoltaic Panels

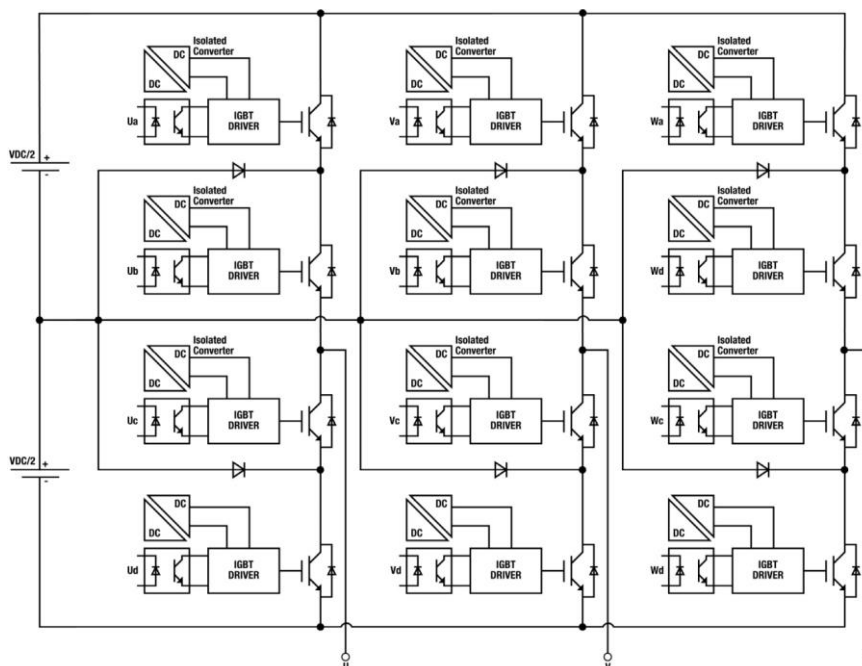

**Figure 15:** Block diagram of a 3 Phase, 3-Level IGBT Inverter

This has been a brief introduction to high isolation voltage DC/DC-converter applications. There are many other fields of use which have not been mentioned, but the four areas mentioned here are the most common applications.

## 6 CONCLUSION

For use in industrial products, operational isolation usually suffices. Here the primary and secondary windings of the transformer are wound overlaying each other. The internal magnetic fields are thereby ideally superimposed. Such a design reduces however safety margins, as both windings are only separated by the respective wire coating thickness. However, for use in above-mentioned applications is safety and certification utmost priority in electronic equipment. These aspects represent high-class demands for DC/DC power supply technology and manufacturer.

### Useful tool to convert isolation values:

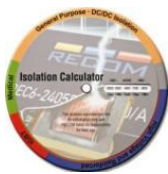

We have produced an easy tool to use the **isolation calculator** that simplifies the often times confusing task of comparing isolation levels that are required for many different types of applications. The calculator can be used when only one isolation period is known whether that is one second or one minute, AC or DC. It also handily separates the isolation requirements by application including general purpose, high voltage/reinforced, IGBT and medical. The calculator also features a reference chart on the reverse side that includes all isolated parts including their isolation rating. This handy calculator has been well received by many engineers who appreciate the simplification of the design process, saving time, and require convenient references for isolated power modules. This useful tool is free of charge and can be ordered directly through RECOM or simple use the online version of the calculator on our website: [www.recom-power.com/support/isolation-calculator](http://www.recom-power.com/support/isolation-calculator).